

Instruction Manual



S10C

CONTENTS

English	1
Français	11
Deutsch	21
Italiano	31
Español	41

General

Working voltage: 11V-16V





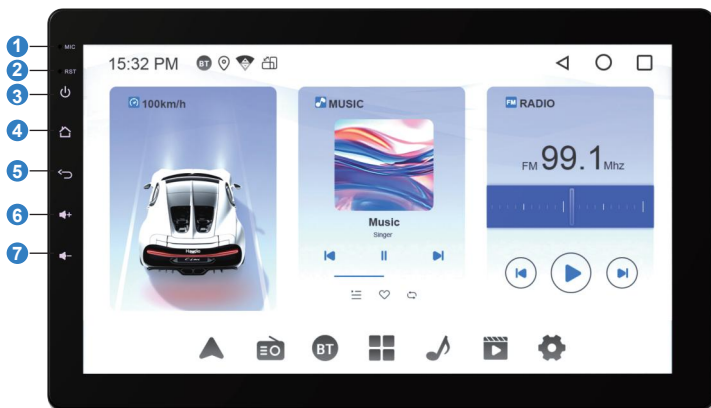

Working temperature: -20°C~+60°C

Working current: 0.8A-1.2A

Storage temperature:-30°C~+80°C

Functional Description



1.  Built-in microphone hole
2.  Reset (press with a sharp object)
3.  Turn off or turn on
4.  Back to Home
5.  Back to previous
6.  Vol+
7.  Vol-

Accessory List

Please check the following accessories after opening the package.

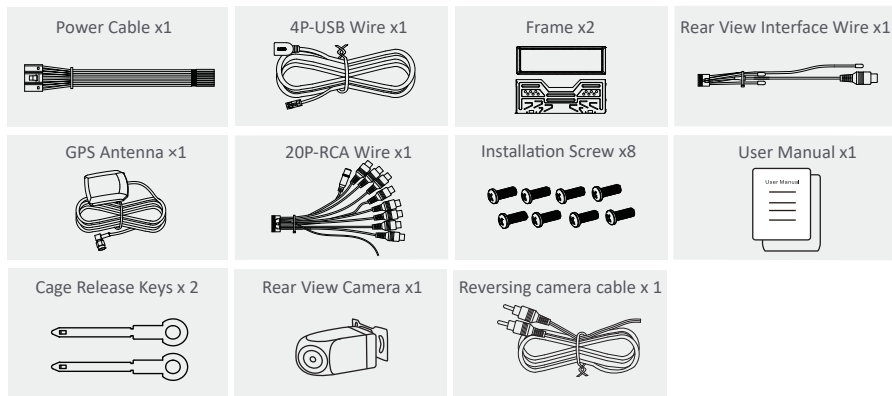

Backinterface Diagram

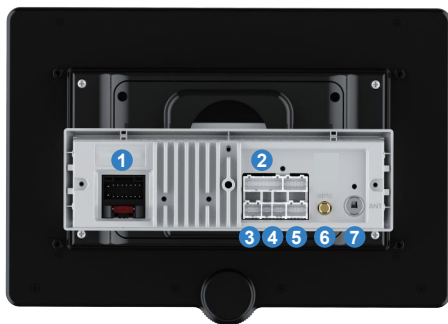

1. Power Cable
2. RCA Input/Output
3. CAN Bus
4. USB Cable x 1
5. Camera Input
6. GPS Antenna
7. Radio Antenna

Installation



Follow the Haudio community. A place where you can share and discuss. Keep in touch with Haudio users. Get the installation tutorial video.

Installation

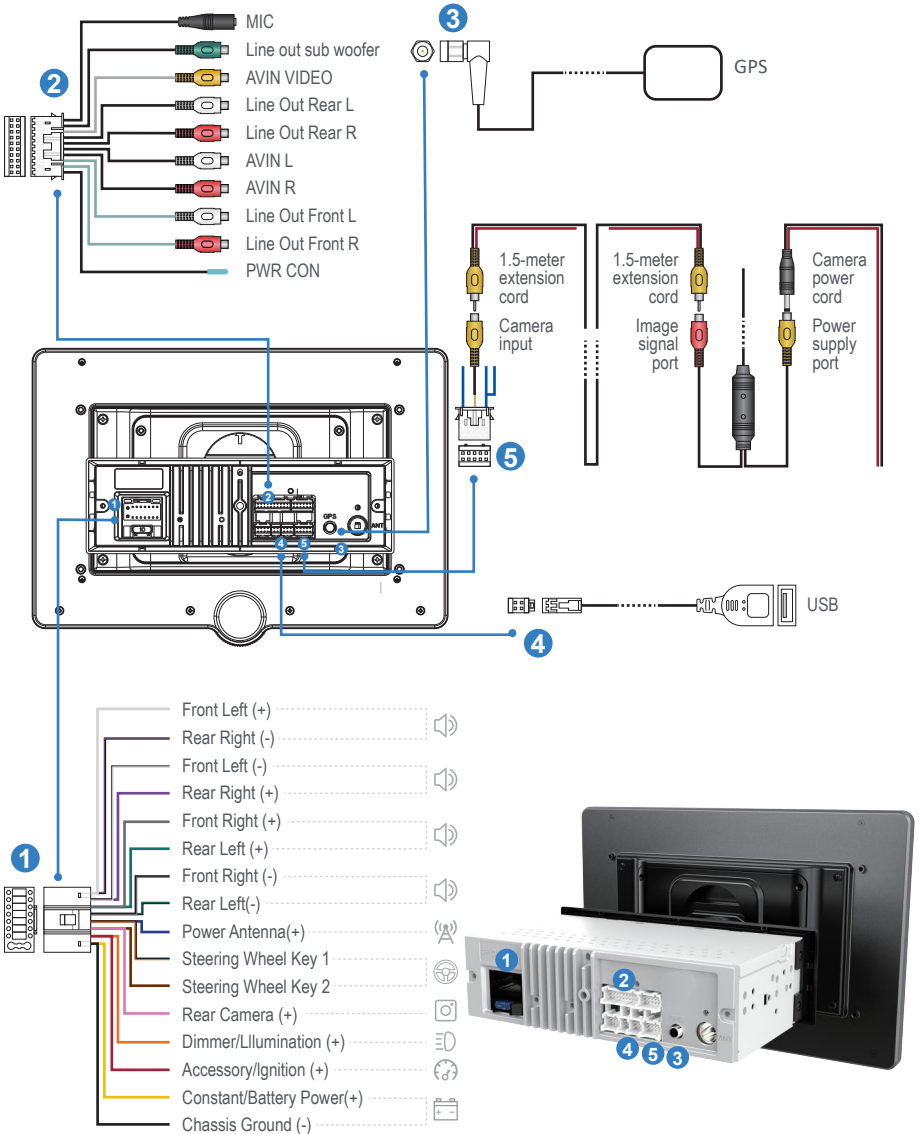

Installation

1. Prepare tools:



2. Remove the original vehicle head unit.



3. Disconnect the wiring of the original head unit.



4. Start the engine to verify whether the car stereo and camera can work properly.



5. After wiring, start the vehicle to verify normal power-on of the unit and proper camera operation.



6. Assembly completed.



Rear view camera wiring (optional)

1. Monitor (Not included in the Package)
2. Camera Power Source
3. Camera (Optional)

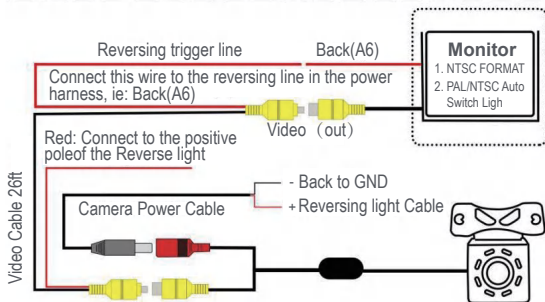
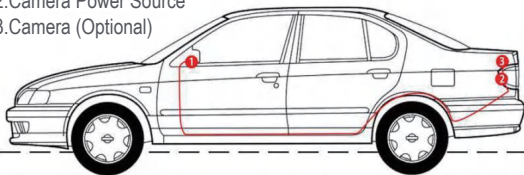

You can reach the power supply in the trunk by going under the original car door, along the edge above the door, or along the wiring on the roof.

1. Pass the camera wiring harness through the storage compartment and connect it to the head unit.



2. Conceal the camera signal wire under the edge of the door and route it to the trunk entrance.



3. The camera is powered by the vehicle's taillights.



Product Introduction

Radio

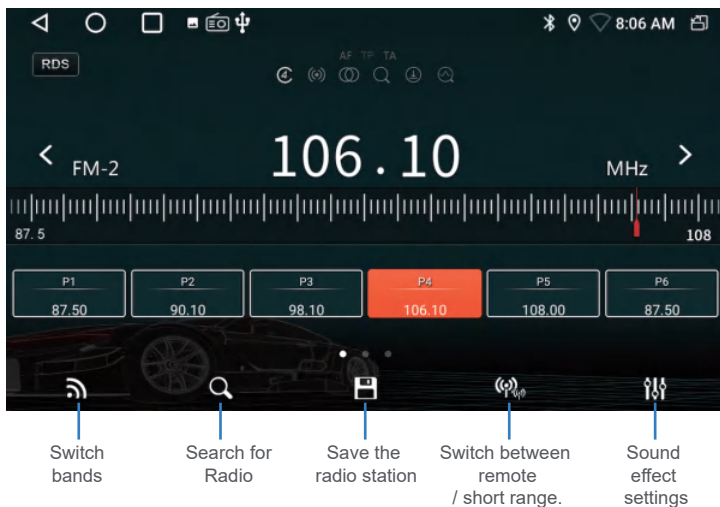

Music

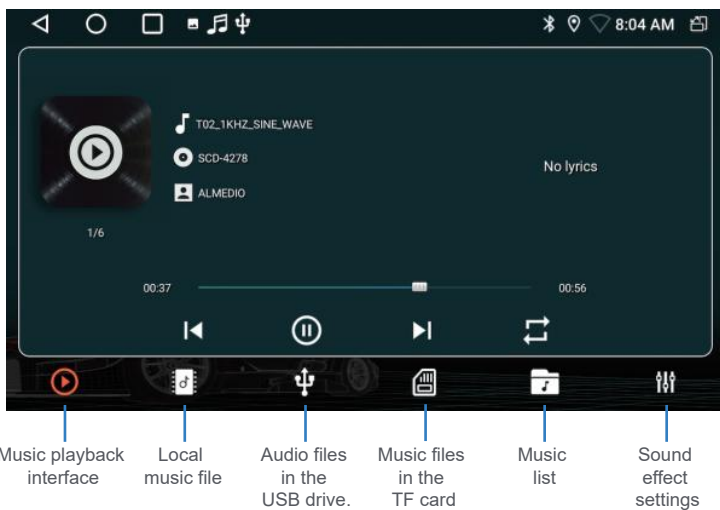

During music playback, slide the playback progress bar to drag to the specified playback node.

Product Introduction

Video

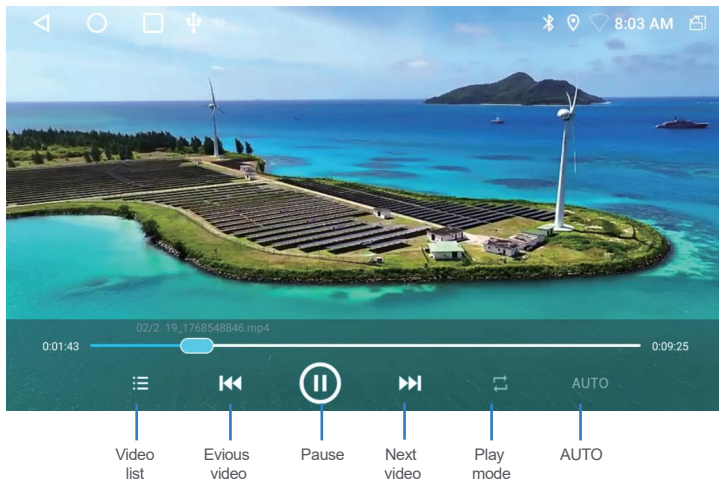

Bluetooth

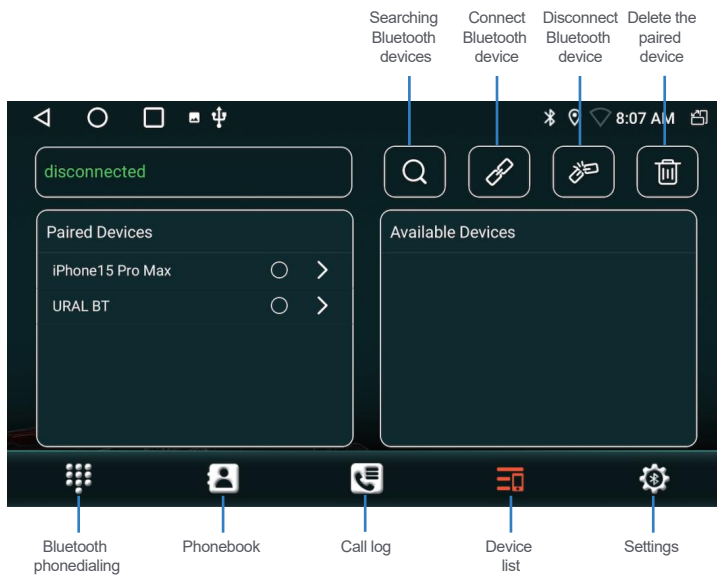

Product Introduction

Bluetooth setting

Restart BT power Turn on this power switch to enable Bluetooth.

Auto Answer Turn on this switch, after the mobile phone is connected to the car Bluetooth, when your mobile phone rings for 5 seconds, it will automatically answer the call.

Auto Connect When this switch is turned on, the phone will automatically answer the call after connecting the Bluetooth of the car and the phone.

Bluetooth net Turn on this switch, after the mobile phone is connected to the Bluetooth of the car, and turn on Bluetooth sharing network switch on the mobile at the same time, the car can access the Internet through the network shared by the mobile. Refer to the detailed introductions on the mobile terminal operation method.

DSP

Operating instructions.



Product Introduction

Wireless connection



Click to CarPlay/Android Auto/Phone Link



Click to switch between Carplay/Android Auto and Mirroring

1. Press to enter Zlink5, the mobile phone can be connected to the in-vehicle infotainment device through Android USB and iPhone Wi-Fi.
2. Wireless Zlink5: iPhone connects the car navigation through BT, click Zlink5 to enter the pop-up dialog box, and click use Zlink5.

Zlink5:(Connection instructions for some iOS mobile phones)

1. Turn on the BT of the mobile phone to connect the BT of the head unit. After the BT connection of the car, the ZLink connection interface will pop up automatically.
2. Confirm using CarPlay on mobile.
3. If the above steps cannot be connected, you need to connect the mobile phone Wi-Fi hotspot.

Common troubleshooting guidelines

FAULT	REASON	SOLUTION
Can not power on	Check fuse	Change fuse same as the old one Maximum current of fuse:15A
	Some factors cause MPU wrong operation	Press RESET button on the panel by penpoint,then, power on
After ignitions with off, setting information all lose	Change battery or fuse	Reset information and save
Poor performance of radio station	Weak signal	Move the car to another location,then research

Do not connect the speaker leads of the power cord to the car battery; otherwise, the unit will be seriously damaged.

BEFORE connecting the speaker leads of the power cord to the speakers, check the speaker wiring in your car.

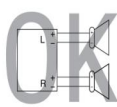
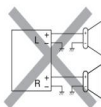
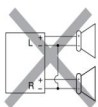

THIS DEVICE COMPLIES WITH PART 15 OF THE FCC RULES AND REGULATIONS.

OPERATION IS SUBJECT TO THE FOLLOWING TWO CONDITIONS:

- 1)THE DEVICE MAY NOT CAUSE HARMFUL INTERFERENCE, AND
- 2)THE DEVICE MUST ACCEPT ANY INTERFERENCE RECEIVED, INCLUDING INTERFERENCE THAT MAY CAUSE UNDESIRED OPERATION

CE

The maximum SAR value is 2W/kg when the device used Omm close to user.

Warning:

The ANT interface is a dedicated RF signal interface and must not be used as a power input port.

Any unauthorized connection of external power sources will result in severe degradation of the signal system or permanent hardware damage to the equipment. All consequences and losses resulting from such unauthorized operations shall be borne by the user themselves and are not covered by the product warranty.

If the product voltage is lower than 12V, the working condition is not guaranteed.

This public version description is subject to the actual product configuration.

Product Warranty Card

Warranty Period:

This product is entitled to 12 months of free repair service from the effective date of purchase.

Warranty Scope:

Under the premise of complying with the usage regulations, any performance failure caused by manufacturing defects of the product itself can enjoy free repair services.

Disclaimer Clause:

The following situations are not within the scope of warranty liability:

1. Damage caused by force majeure (such as earthquakes, fires, floods, typhoons, etc.);
2. Malfunctions caused by improper use, maintenance, and storage by consumers;
3. Damage caused by unauthorized personnel dismantling, repairing, or modifying without the authorization of our company;
4. The warranty certificate does not match the product information or the certificate has been altered or missing;
5. The product has exceeded the agreed warranty period;
6. Appearance wear and natural aging of consumables caused by normal use.

Service Channels:

If you need technical support or warranty services, please contact us

Through the following methods:

Customer Service Email: info@tianshi-digital.com

Service website: <https://tianshi-digital.com>

We suggest that you prioritize initiating service requests through the official customer service channel of the original purchasing platform.

Purchase Date		Serial Number	
Product Model		Contact Email	

Général

Tension de travail: 11V-16V





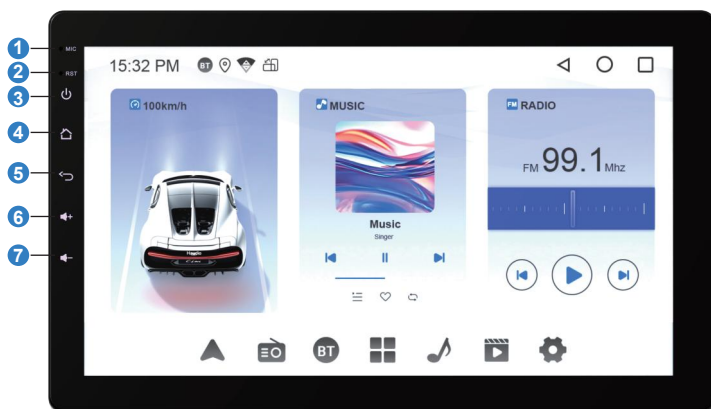

Température de travail: -20°C-+60°C

Courant de travail: 0.8A-1.2A

Température de stockage: -30°C-+80°C

Description fonctionnelle



1.  Ouverture du microphone intégré
2.  Réinitialiser (appuyez avec un objet pointu)
3.  Désactiver ou allumer
4.  Retour à l'accueil
5.  Retour à l'endroit précédent
6.  Vol+
7.  Vol-

Liste des accessoires

Veillez vérifier les accessoires suivants après avoir ouvert le paquet.



Diagramme de l'interface arrière



1. Câble d'alimentation
2. Entrée/sortie RCA
3. Bus CAN
4. Câble USB x 1
5. Entrée de caméra
6. Antenne GPS
7. Antenne radio

Installation

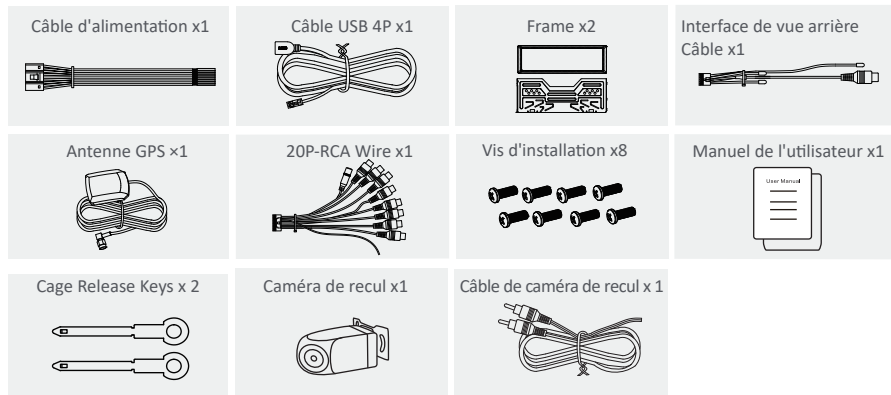

Suivez la communauté Haudio. Un endroit où vous pouvez partager et discuter. Restez en contact avec les utilisateurs Haudio. Obtenez la vidéo tutoriel d'installation.

Installation

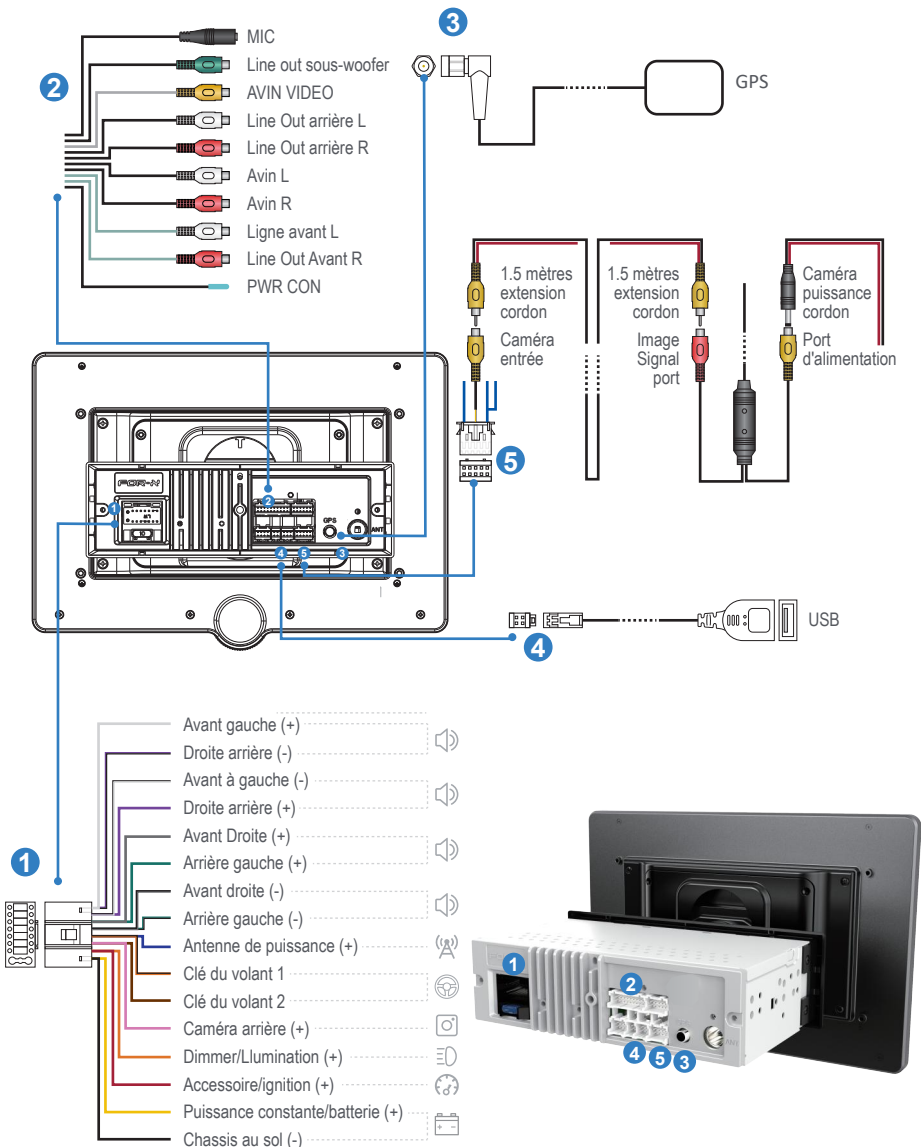

Installation

1. Préparer les outils :



2. Retirez l'unité de commande originale du véhicule.



3. Débranchez le câblage de l'unité audio d'origine.



4. Démarrer le moteur pour vérifier si le système audio et la caméra de la voiture fonctionnent correctement.



5. Après le câblage, démarrez le véhicule pour vérifier que l'unité s'allume normalement et que la caméra fonctionne correctement.



6. Assemblage terminé.



Câblage de caméra de vue arrière (facultatif)

1. Monitor (non inclus dans l'emballage)

Source d'alimentation 2. Camera

3. Camera (facultatif)

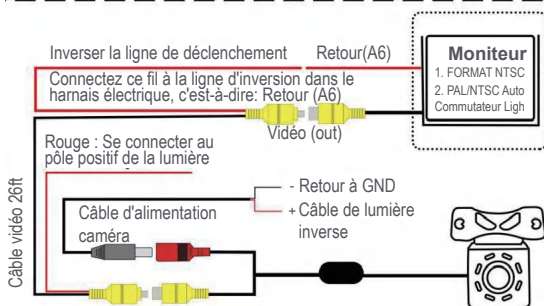
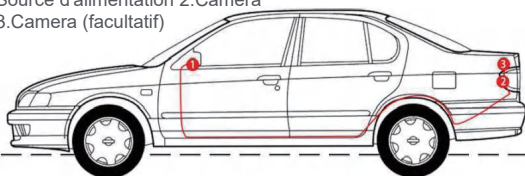

1. Faire passer le câble de la caméra par le compartiment de stockage et le connecter à l'unité centrale.



2. Cachez le câble du signal de la caméra sous le bord de la porte et dirigez-le vers l'entrée du coffre.



L'appareil photo est alimenté par les feux arrière du véhicule.



Vous pouvez atteindre l'alimentation électrique dans le coffre en allant sous la porte d'origine de la voiture, le long du bord au-dessus de la porte, ou le long du câblage sur le toit.

Introduction du produit

La radio

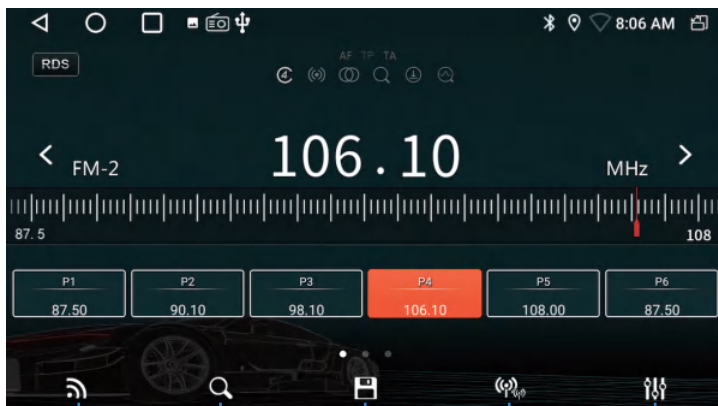

Commutateur bandes

Rechercher Radio

Enregistrer la station de radio

Basculer entre télécommande / courte portée.

Paramètres des effets sonores

Musique

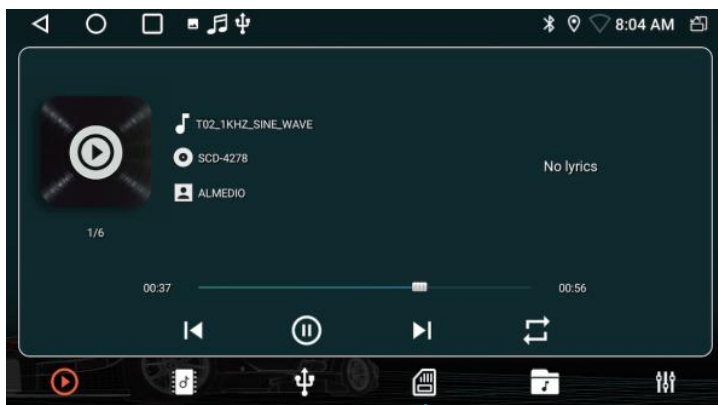

Interface de lecture musicale

Local fichier musical

Fichiers audiosur la clé USB.

Fichiers Musicaux sur la carte TF

Liste musicale

Paramètres des effets sonores

Pendant la lecture de musique, faites glisser la barre de progression de lecture pour faire glisser vers le nœud de lecture spécifié.

Introduction du produit

Vidéo

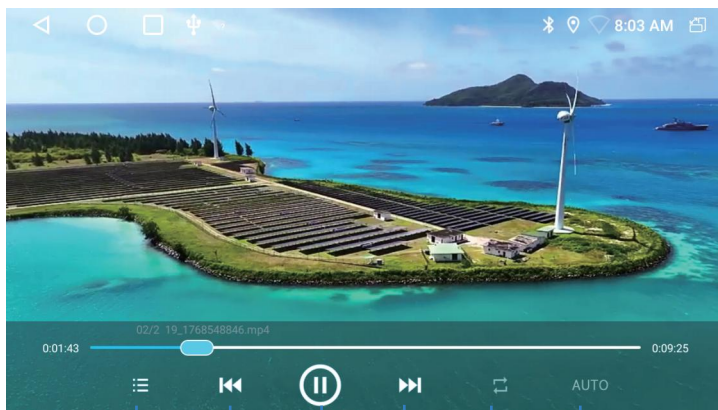

Liste des vidéos

Idéo méchante

Pause

Vidéo suivante

Mode de lecture

AUTO

Bluetooth

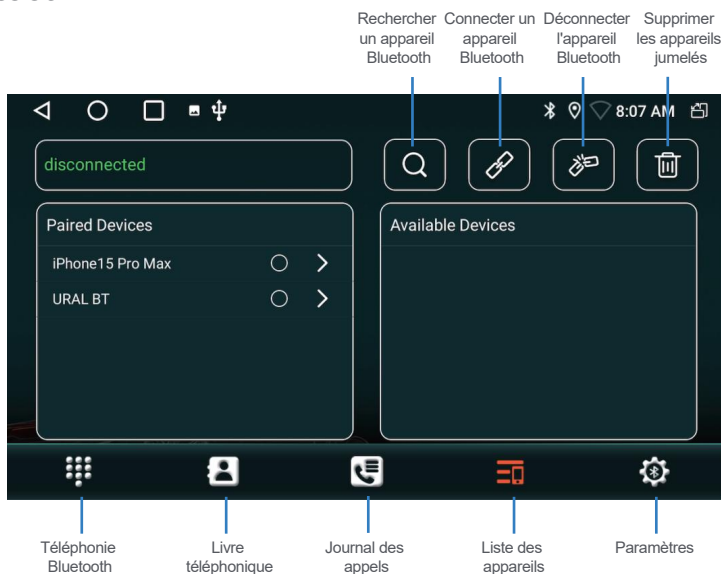

Introduction du produit

Paramètres Bluetooth

Restart BT power Activez cet interrupteur d'alimentation pour activer le Bluetooth.

Auto Answer Activez cet interrupteur, après que le téléphone mobile est connecté à la voiture Bluetooth, lorsque votre téléphone mobile sonne pendant 5 secondes, il répondra automatiquement à l'appel.

Auto Connect Lorsque cet interrupteur est activé, le téléphone répondra automatiquement à l'appel après avoir connecté le Bluetooth de la voiture et du téléphone.

Bluetooth net Activez ce commutateur, après que le téléphone mobile est connecté au Bluetooth de la voiture, et activez le commutateur de réseau Bluetooth sur le mobile en même temps, la voiture peut accéder à Internet via le réseau partagé par le mobile. Se référer aux introductions détaillées sur la méthode de fonctionnement du terminal mobile.

DSP

Instructions d'utilisation.



Introduction du produit

Connexion sans fil



Cliquez sur le lien CarPlay/Android Auto/Phone



Cliquez pour passer entre Carplay/Android Auto et Mirroring

1. Appuyez pour entrer Zlink5, le téléphone mobile peut être connecté au dispositif d'infotainment à l'intérieur du véhicule via Android USB et iPhone Wi-Fi.
2. Zlink5 sans fil: l-i-phone connecte la navigation de voiture à travers BT, cliquez sur Zlink5 pour entrer dans la boîte de dialogue pop-up et cliquez sur utiliser Zlink5.

Zlink:(Instructions de connexion pour certains téléphones mobiles iOS)

1. Mettez en marche le BT du téléphone mobile pour connecter le BT de l'unité de tête. Après la connexion BT de la voiture, l'interface de connexion ZLink s'affichera automatiquement.
2. Confirmez l'utilisation de CarPlay sur mobile.
3. Si les étapes ci-dessus ne peuvent pas être connectées, vous devez connecter le téléphone mobile WiFihotspot.

Directives de dépannage courantes

FAUTE	RAISON	SOLUTION
Impossible d'allumer	Vérifier le fusible	Remplacer le fusible comme l'ancien. Intensité maximale du fusible : 15 A
	Certains facteurs provoquent un dysfonctionnement du microprocesseur	Appuyez sur le bouton RESET du panneau avec la pointe du stylo, puis allumez l'appareil.
Après avoir coupé le contact, toutes les informations de réglage sont perdues.	Changer la batterie ou le fusible	Réinitialiser les informations et enregistrer
Mauvaise performance de la station de radio	Signal faible	Déplacez la voiture vers un autre endroit, puis effectuez des recherches.

Ne connectez pas les câbles d'alimentation des haut-parleurs à la batterie du véhicule ; cela pourrait endommager gravement l'appareil.

AVANT de connecter les câbles d'alimentation aux haut-parleurs, vérifiez le câblage des haut-parleurs de votre véhicule.

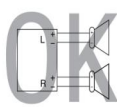
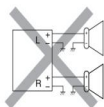
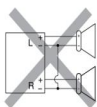

CET APPAREIL EST CONFORME À LA PARTIE 15 DES RÈGLES ET RÉGLEMENTATIONS DE LA FCC. SON FONCTIONNEMENT EST SOUMIS AUX DEUX CONDITIONS SUIVANTES :

- 1) L'APPAREIL NE DOIT PAS PROVOQUER D'INTERFÉRENCES NUISIBLES, ET
- 2) L'APPAREIL DOIT ACCEPTER TOUTE INTERFÉRENCE RECUE, Y COMPRIS CELLE POUVANT ENTRAÎNER UN FONCTIONNEMENT INDÉSIRABLE.

CE

The maximum SAR value is 2W/kg when the device used Omm close to user.

Avertissement :

L'interface ANT est une interface de signal RF dédiée et ne doit pas être utilisée comme port d'entrée d'alimentation. Toute connexion non autorisée de sources d'alimentation externes entraînera une grave dégradation du système de signal ou des dommages matériels permanents à l'équipement.

Toutes les conséquences et pertes résultant de telles opérations non autorisées sont à la charge de l'utilisateur lui-même et ne sont pas couvertes par la garantie du produit.

Si la tension du produit est inférieure à 12V, l'état de travail n'est pas garanti.

Cette description de la version publique est soumise à la configuration réelle du produit.

Carte de garantie du produit

Période de garantie :

Ce produit a droit à un service de réparation gratuit de 12 mois à compter de la date d'achat.

Portée de la garantie:

Sous la prémisses du respect des règlements d'utilisation, toute défaillance de performance causée par des défauts de fabrication du produit lui-même peut bénéficier de services de réparation gratuits.

Clause d'exclusion de responsabilité :

Les situations suivantes ne sont pas couvertes par la garantie:

1. Dégâts causés par la force majeure (tels que tremblements de terre, incendies, inondations, typhons, etc.);
2. Malfunctionnements causés par une utilisation, une maintenance et un stockage inappropriés par les consommateurs;
3. Dommages causés par le démontage, la réparation ou la modification du personnel non autorisé sans l'autorisation de notre société;
4. Le certificat de garantie ne correspond pas aux informations du produit ou le certificat a été modifié ou manquant;
5. Le produit a dépassé la période de garantie convenue;
6. Apparence usure et vieillissement naturel des consommables causés par l'utilisation normale.

Chaînes de service :

Si vous avez besoin d'assistance technique ou de services de garantie, veuillez nous contacter par **les méthodes suivantes:**

Courriel du service à la clientèle : info@tianshi-digital.com

Site Web de service: <https://tianshi-digital.com>

Nous vous suggérons de prioriser l'initiation des demandes de service par l'intermédiaire du client officiel. canal de service de la plateforme d'achat originale.

Date d'achat		Numéro de série	
Modèle de produit		Contact Email	

Allgemein

Arbeitsspannung: 11V-16V

Arbeitstemperatur: -20°C-+60°C

Arbeitsstrom: 0.8A-1.2A

Lagertemperatur: -30°C-+80°C



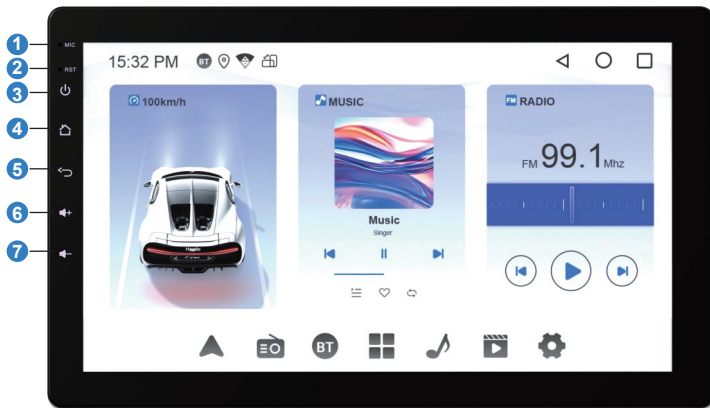







Funktionale Beschreibung

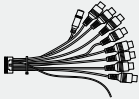

1. Eingebautes Mikrofonloch
2. Reset (mit einem scharfen Objekt drücken)
3. Ausschalten oder einschalten
4. Zurück zu
5. Zurück zur vorherigen Seite
6. Vol+
7. Vol-

Zubehörliste

Bitte überprüfen Sie das folgende Zubehör nach dem Öffnen der Verpackung.

Stromkabel x1 	4P-USB-Kabel x1 	Frame x2 	Rückansichtsinterface-Kabel x1 
GPS Antenna x1 	20P-RCA-Kabel x1 	Montagebolzen x8 	Bedienungsanleitung x1 
Käfigfreisetzungsschlüssel x2 	Rückfahrkamera x1 	Umkehrlinse-Kabel x1 	

Backinterface Diagramm

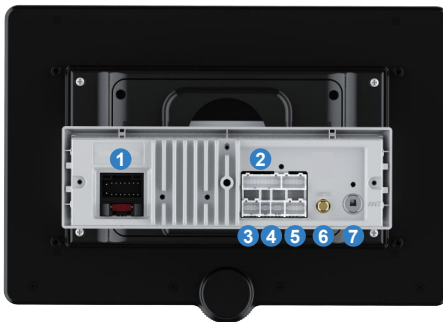

1. Stromkabel
2. RCA-Eingang/Ausgang
3. CAN Bus
4. USB-Kabel x 1
5. Kameraeingang
6. GPS-Antenne
7. Radioantenne

Installation



Folgen Sie der Haudio Community. Ein Ort, an dem Sie teilen und diskutieren können. Bleiben Sie in Kontakt mit Haudio-Nutzern. Holen Sie sich das Installations-Tutorial-Video.

Installation

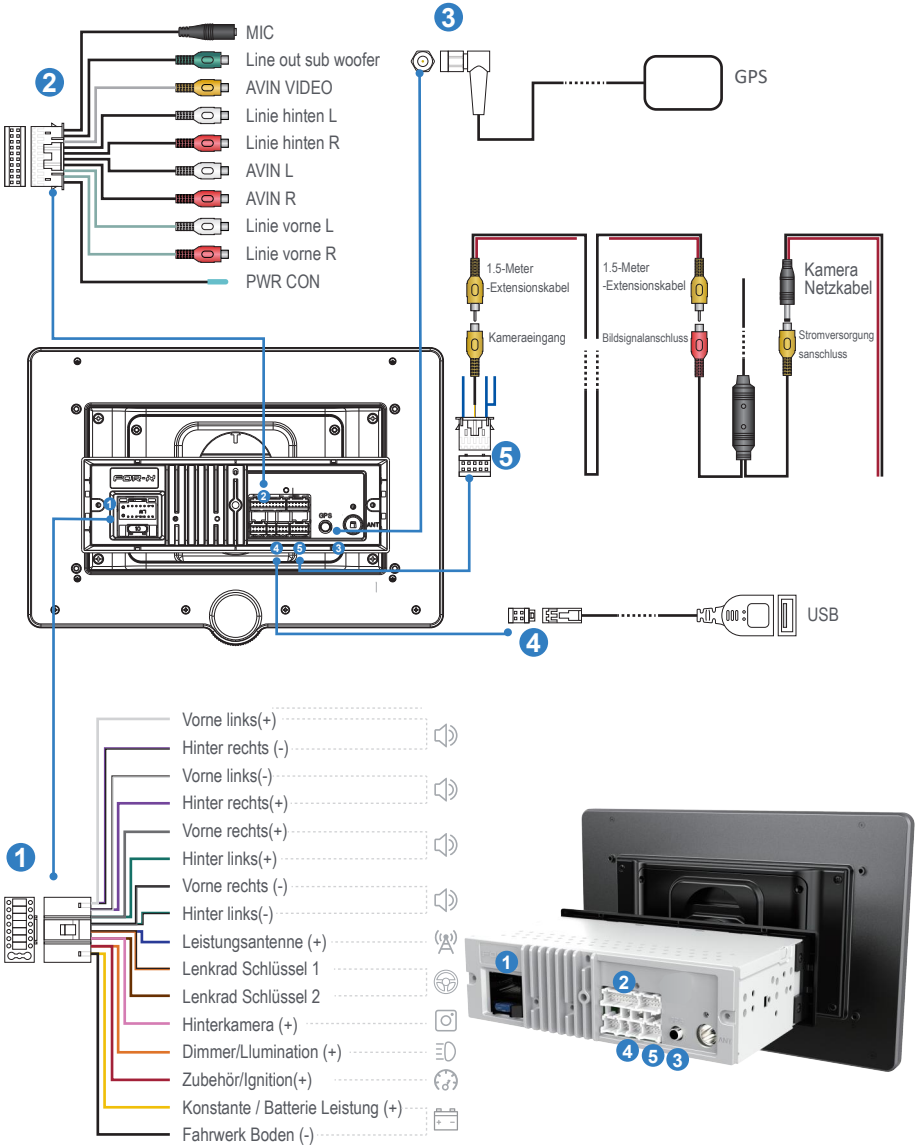

Installation

1. Werkzeuge vorbereiten:



4. Starten Sie den Motor, um zu überprüfen, ob die Autowerkstatt und die Kamera ordnungsgemäß funktionieren.



2. Entfernen Sie die ursprüngliche Fahrzeug-Headunit.



5. Nach der Verkabelung starten Sie das Fahrzeug, um die normale Stromversorgung der Einheit und die ordnungsgemäße Funktion der Kamera zu überprüfen.



3. Trennen Sie die Verkabelung der ursprünglichen Headunit.



6. Montage abgeschlossen.



Rücksicht Kamera Verkabelung (optional)

1. Monitor (nicht im Paket enthalten)
2. Kamera Stromquelle
3. Kamera (optional)

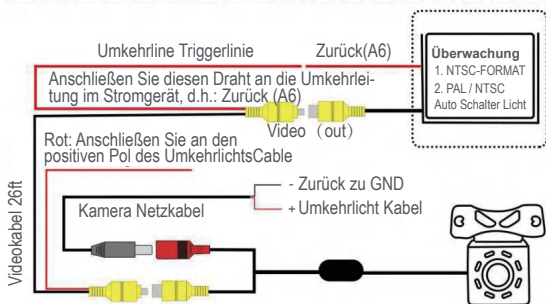
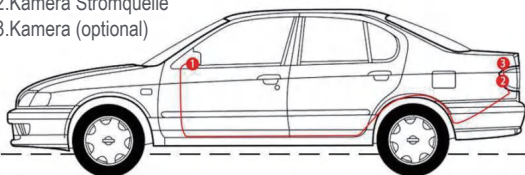

Sie können die Stromversorgung im Kofferraum erreichen, indem Sie unter der ursprünglichen Autotür gehen, entlang des Randes über der Tür oder entlang der Verkabelung auf dem Dach.

1. Schieben Sie das Kamerakabel durch den Stauraum und verbinden Sie es mit der Head Unit.



2. Verstecken Sie das Kamerensignalsignal unter den Türkanten und führen Sie es zum Kofferraum-Einstieg.



Die Kamera bezieht ihre Stromversorgung von den Rücklichtern des Fahrzeugs.



Produkteinführung

Radio



Musik

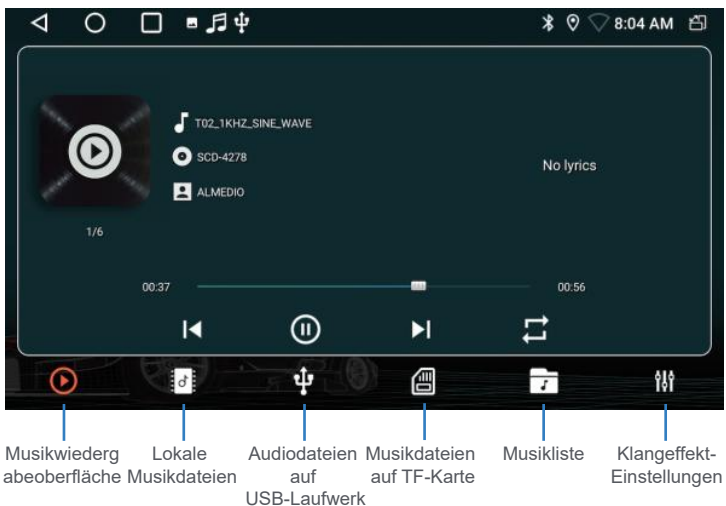

Schieben Sie während der Musikwiedergabe die Fortschrittsleiste der Wiedergabe, um den angegebenen Wiedergabeknoten zu ziehen.

Produkteinführung

Videos

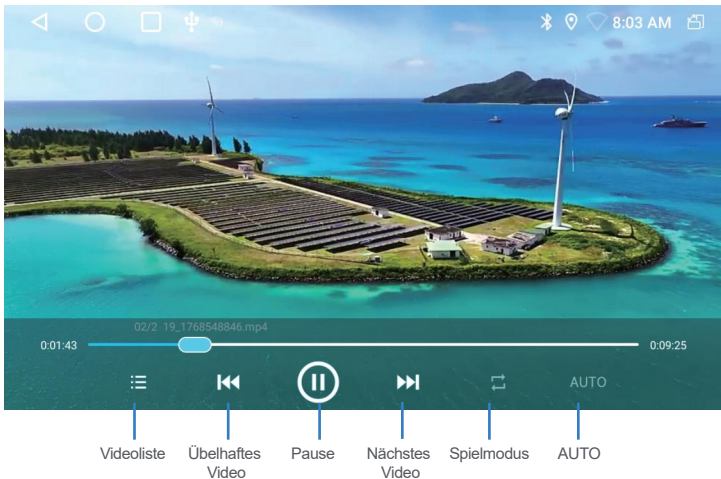

Bluetooth



Produkteinführung

Bluetooth-Einstellung

Restart BT power Schalten Sie diesen Stromschalter an, um Bluetooth zu aktivieren.

Auto Answer Schalten Sie diesen Schalter an, nachdem das Handy mit dem Auto Bluetooth verbunden ist, wenn Ihr Handy für 5 Sekunden klingelt, wird es den Anruf automatisch beantworten.

Auto Connect Wenn dieser Schalter eingeschaltet ist, beantwortet das Telefon automatisch den Anruf nach dem Anschluss des Bluetooth des Autos und des Telefons.

Bluetooth net Schalten Sie diesen Schalter ein, nachdem das Handy mit dem Bluetooth des Autos verbunden ist und gleichzeitig den Bluetooth-Sharing-Netzwerkschalter auf dem Handy einschalten, kann das Auto über das vom Handy geteilte Netzwerk auf das Internet zugreifen. Siehe die detaillierten Einführungen zum Betriebsverfahren des mobilen Terminals.

DSP

Betriebsanweisungen



Produkteinführung

Drahtlose Verbindung



Klicken Sie auf CarPlay/Android Auto/Phone Link



Klicken Sie, um zwischen Carplay/Android Auto und Mirroring zu wechseln

1. Drücken Sie, um Zlink5 einzugeben, kann das Handy über Android USB und iPhone Wi-Fi an das Fahrzeuginfotainment-Gerät angeschlossen werden.
2. Wireless Zlink5: I-phone verbindet die Autonavigation durch BT, klicken Sie auf Zlink5, um das Pop-up-Dialogfeld einzugeben, und klicken Sie auf Zlink5 verwenden.

Zlink:(Verbindungsanweisungen für einige iOS-Handys)

1. Schalten Sie den BT des Handys ein, um den BT der Kopfeinheit anzuschließen. Nach dem BTconnection des Autos erscheint automatisch die ZLink-Anschlusschnittstelle.
2. Bestätigen Sie die Verwendung von CarPlay auf Mobilgeräten.
3. Wenn die oben genannten Schritte nicht angeschlossen werden können, müssen Sie das Handy WiFihotspot anschließen.

Allgemeine Fehlersuche-Anleitungen

FEHLER	GRÜNDE	LÖSUNG
Kann nicht eingeschaltet werden	Sicherung überprüfen	Wechseln Sie die Sicherung wie die alte Maximaler Strom der Sicherung: 15A
	Einige Faktoren Ursache MPU falsch	Drücken Sie die RESET-Taste auf dem Panel durchpenpoint, then, power on
Nach der Zündung abschalten, einstellen Informationen verlieren alle	Batterie wechseln oder Sicherung	Informationen zurücksetzen und speichern
Schlechte Leistung des Radiosenders	Schwaches Signal	Verschieben Sie das Auto zu einem anderen Standort, dann Forschung

Schließen Sie die Lautsprecherkabel des Netzkabels nicht an die Autobatterie an. Andernfalls wird das Gerät ernsthaft beschädigt.
VOR Anschließen der Lautsprecherkabel an die Lautsprecher, Überprüfen Sie die Lautsprecherverkabelung in Ihrem Auto.

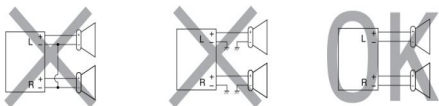

DIESES GERÄT STIMMT MIT TEIL 15 DER FCC-REGULIERUNGEN ÜBEREIN. DER BETRIEB IST DER FOLGENDEN ZWEI BEDINGUNGEN GENEHMIGT:

- 1) DIE VORRICHTUNG DARF KEINE GEFAHRLICHEN STÖRUNGEN VERURSACHEN, UND
- 2) DIE VORRICHTUNG MUSS JEDE EMPFANGENE STÖRUNG AKZEPTIEREN, EINSCHLIEßLICH STÖRUNG, DIE ZU UNBEWUNSCHTEN AUSLAUFSFOLGEN FÜHREN KANN

CE

Der maximale SAR-Wert beträgt 2W/kg, wenn das Gerät Omm nahe am Benutzer verwendet.

Warnung:

Die ANT-Schnittstelle ist eine dedizierte HF-Signalschnittstelle und darf nicht als Leistungseingangsanschluss verwendet werden. Jede unbefugte Verbindung externer Stromquellen führt zu einer schweren Verschlechterung des Signalsystems oder dauerhaften Hardwareschäden an der Ausrüstung. Alle Folgen und Verluste, die sich aus solchen unbefugten Vorgängen ergeben, tragen der Nutzer selbst und sind nicht von der Produktgarantie abgedeckt.

Wenn die Produktspannung unter 12V liegt, ist der Arbeitszustand nicht garantiert.

Diese öffentliche Versionsbeschreibung richtet sich nach der tatsächlichen Produktausstattung.

Produktgarantiekarte

Garantiefrist:

Dieses Produkt hat Anspruch auf 12 Monate kostenlosen Reparaturservice ab dem Wirkungsdatum des Kaufs.

Warranty Scope:

Under the premise of complying with the usage regulations, any performance failure caused by manufacturing defects of the product itself can enjoy free repair services.

Garantiebereich:

The following situations are not within the scope of warranty liability:

Folgende Situationen fallen nicht im Rahmen der Gewährleistungshaftung:

1. Schäden durch höhere Gewalt (wie Erdbeben, Brände, Überschwemmungen, Taifun usw.);
2. Fehlfunktionen durch unsachgemäße Verwendung, Wartung und Lagerung durch Verbraucher verursacht;
3. Schäden, die durch unbefugtes Personal verursacht werden, demontiert, repariert oder modifiziert ohne Genehmigung unseres Unternehmens;
4. Das Garantiezertifikat entspricht nicht den Produktinformationen oder das Zertifikat wurde geändert oder fehlt;
5. Das Produkt hat die vereinbarte Garantiefrist überschritten;
6. Aussehen Verschleiß und natürliche Alterung von Verbrauchsmaterialien durch normale Verwendung verursacht.

Servicekanäle:

Wenn Sie technischen Support oder Garantiedienstleistungen benötigen, kontaktieren Sie uns bitte über die folgenden Methoden:

Kundendienst Email: info@tianshi-digital.com

Service-Website: <https://tianshi-digital.com>

Wir empfehlen Ihnen, die Initiation von Serviceanfragen über den offiziellen Kunden zu priorisieren.

Service-Kanal der ursprünglichen Einkaufsplattform.

Kaufdatum		Seriennummer	
Produkt Modell		Kontakt E-Mail	

Generale

Tensione di lavoro: 11V-16V





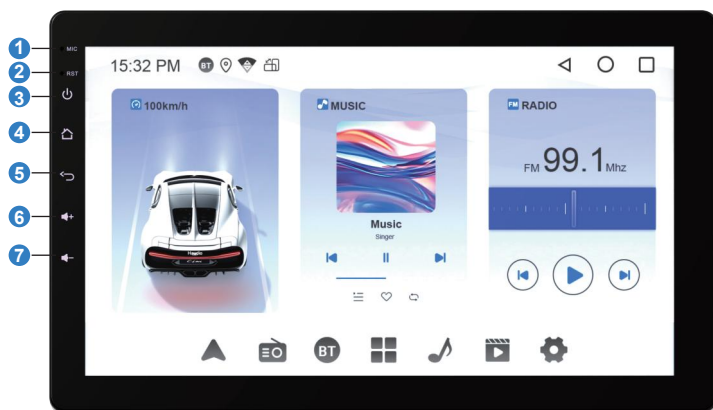

Temperatura di lavoro: -20°C-+60°C

Corrente di lavoro: 0.8A-1.2A

Temperatura di conservazione: -30°C-+80°C

Descrizione funzionale



1.  Foro microfono incorporato
2.  Reset (premere con un oggetto tagliente)
3.  Spegnerne o accendere
4.  Torna a casa
5.  Torna al precedente
6.  Vol+
7.  Vol-

Elenco degli accessori

Si prega di controllare i seguenti accessori dopo aver aperto il pacchetto.







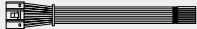

Cavo di alimentazione x1 	4P-USB Cavo x1 	Frame x2 	Cavo dell'interfaccia per la visuale posteriore x1 
Antenna GPS x1 	20P-RCA Cavo x1 	Viti di installazione x8 	Manuale utente x1 
Chiavi di rilascio della gabbia x 2 	Telecamera posteriore x1 	Cavo della telecamera per retromarcia x 1 	

Diagramma dell'interfaccia posteriore

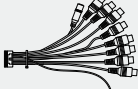

1. Cavo di alimentazione
2. Ingresso/uscita RCA
3. Può autobus
4. Cavo USB x 1
5. Ingresso della fotocamera
6. Antenna GPS
7. Antenna radio

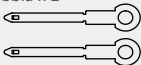
Installazione



Segui la comunità Haudio. Un luogo dove condividere e discutere.
Rimani in contatto con gli utenti Haudio. Ottieni il video tutorial di installazione.

Installazione

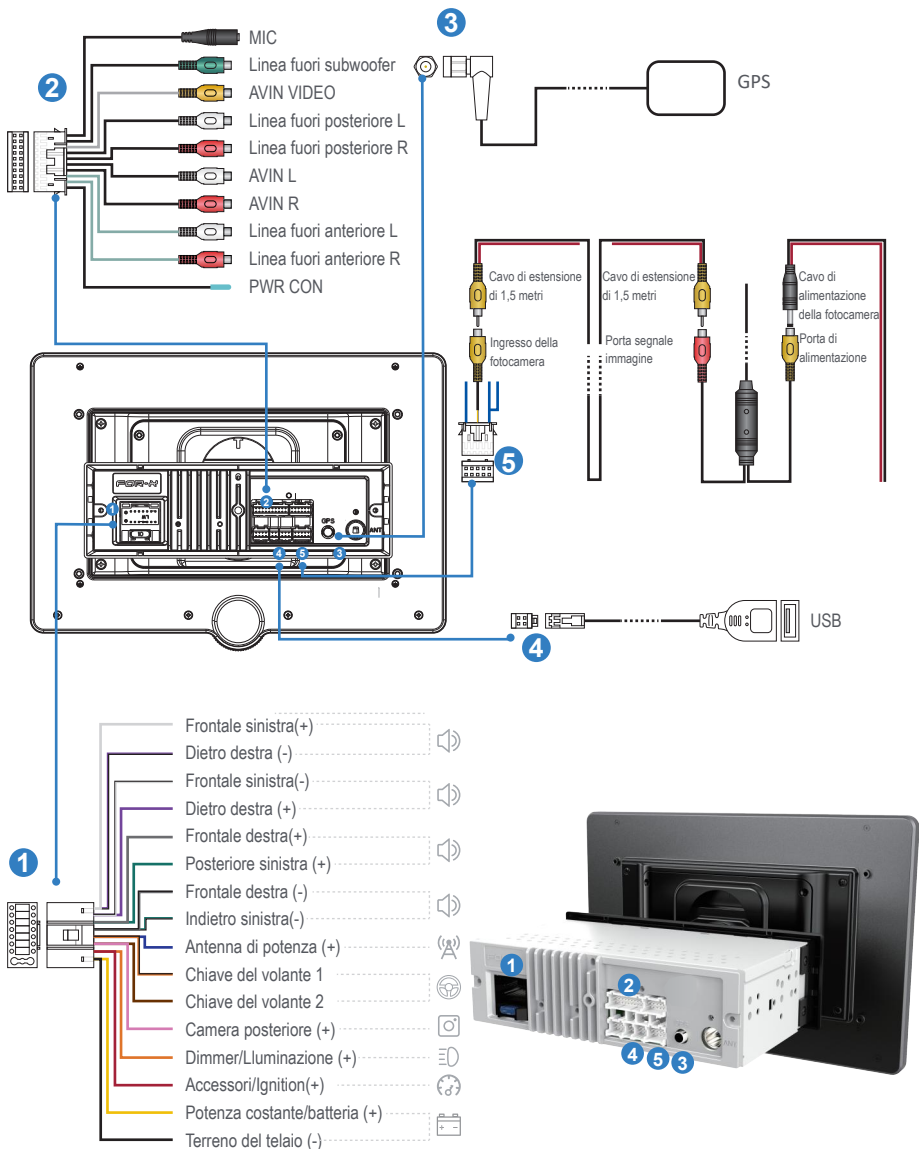

Installazione

1. Preparare gli strumenti:



2. Rimuovere l'unità audio originale del veicolo.



3. Disconnettere il cablaggio dell'unità principale originale.



4. Avvia il motore per verificare se il sistema audio dell'auto e la telecamera funzionano correttamente.



5. Dopo il cablaggio, avviare il veicolo per verificare il normale accensione dell'unità e il corretto funzionamento della telecamera.



6. Montaggio completato.



Cablaggio della fotocamera posteriore (opzionale)

1. Monitor (non incluso nel pacchetto)
2. Camera fonte di alimentazione
3. Camera (facoltativo)

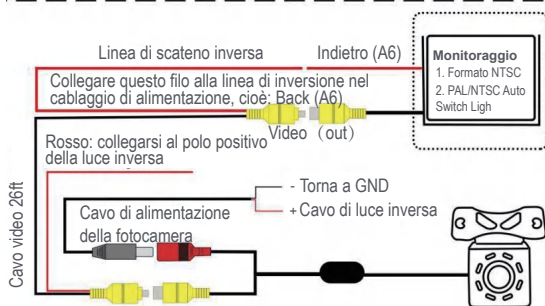
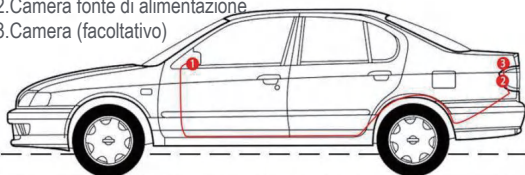

1. Passa il cavo della telecamera attraverso lo scomparto di stoccaggio e collegalo all'unità principale.



2. Nascondi il cavo del segnale della telecamera sotto il bordo della porta e dirigilo verso l'ingresso del bagagliaio.



La camera ottiene energia de las luces traseras del vehiculo.



È possibile raggiungere l'alimentatore nel bagaglio andando sotto la porta originale dell'auto, lungo il bordo sopra la porta o lungo il cablaggio sul tetto.

Introduzione del prodotto

Radio



Cambio banda

Ricerca radio

Salva
stazione radio

Passaggio
tra lunga
/ corta portata

Impostazioni
effetti sonori

Musica

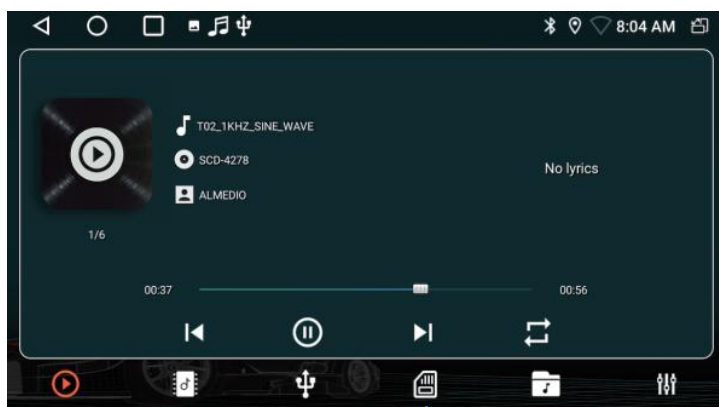

Interfaccia
riproduzione
musica

File musicali
locali

File audio
su unità USB

File musicali
su scheda TF

Elenco musica

Impostazioni
effetti sonori

Durante la riproduzione della musica, scorrere la barra di progresso della riproduzione per trascinare al nodo di riproduzione specificato.

Introduzione del prodotto

Video

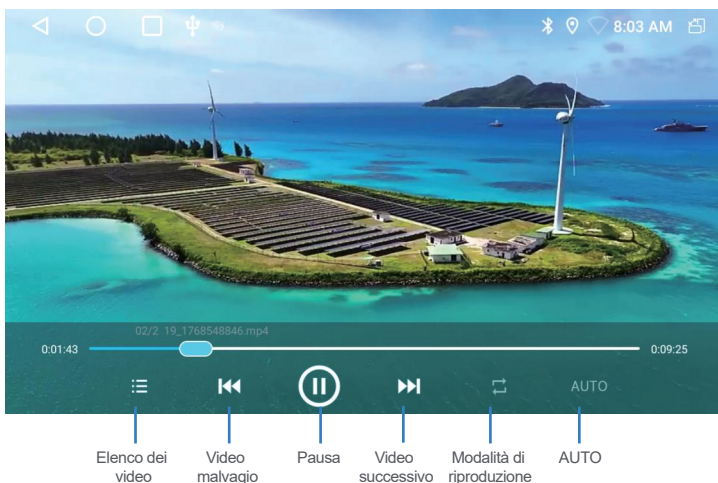

Bluetooth

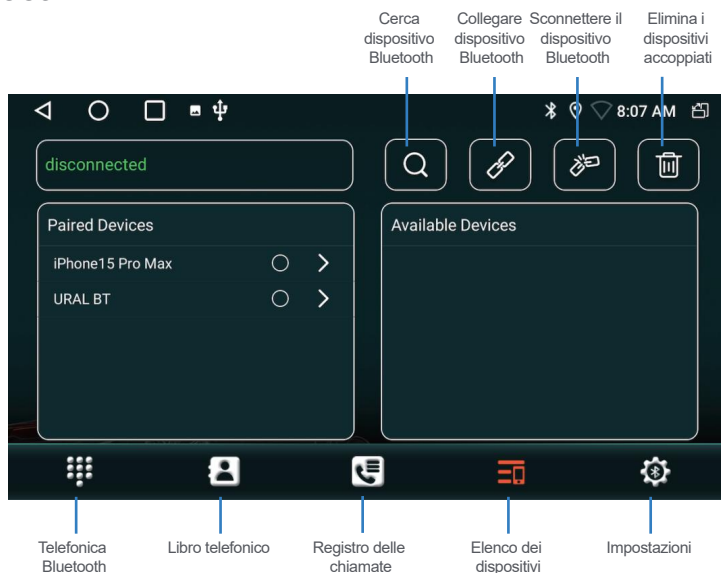

Introduzione del prodotto

Impostazione Bluetooth

Restart BT power

Attiva questo interruttore di alimentazione per abilitare Bluetooth.

Auto Answer

Attiva questo interruttore, dopo che il telefono cellulare è collegato al Bluetooth dell'auto, quando il telefono cellulare suona per 5 secondi, risponderà automaticamente alla chiamata.

Auto Connect

Quando questo interruttore è attivato, il telefono risponderà automaticamente alla chiamata dopo aver collegato il Bluetooth dell'auto e del telefono.

Bluetooth net

Attivare questo interruttore, dopo che il telefono cellulare è collegato al Bluetooth dell'auto, e attivare lo interruttore di rete di condivisione Bluetooth sul cellulare allo stesso tempo, l'auto può accedere a Internet attraverso la rete condivisa dal cellulare. Fai riferimento alle introduzioni dettagliate sul metodo di funzionamento del terminale mobile.

DSP

Istruzioni operative.



Introduzione del prodotto

Connessione wireless



Clicca sul collegamento CarPlay/Android Auto/Phone



Clicca per passare tra Carplay/Android Auto e Mirroring

1. Premere per inserire Zlink5, il telefono cellulare può essere collegato al dispositivo di infotainment in-vehicle tramite Android USB e iPhone Wi-Fi.

2. Wireless Zlink5: l-iphone collega la navigazione dell'auto attraverso BT, fare clic su Zlink5 per entrare nella finestra di dialogo pop-up e fare clic su utilizzare Zlink5.

Zlink:(Istruzioni di connessione per alcuni telefoni cellulari iOS)

1. Accendere il BT del telefono cellulare per collegare il BT dell'unità di testa. Dopo la connessione BT dell'auto, l'interfaccia di connessione ZLink apparirà automaticamente.

2. Conferma l'utilizzo di CarPlay sul cellulare.

3. Se i passaggi sopra non possono essere collegati, è necessario collegare il telefono cellulare WiFihotspot.

Orientamenti comuni per la risoluzione dei problemi

FAULT	REASON	SOLUZIONE
Non si può accendere	Controlla il fusibile	Cambia la fusibile come quella vecchia Corrente massima dell'interruttore: 15A
	Alcuni fattori causa MPU sbagliato operazione	Premere il pulsante RESET sul pannello penpoint, poi, accendi la potenza
Dopo le accensioni con off, impostazione tutte le informazioni perse	Cambiare la batteria o fusione	Reimposta le informazioni e salva
Pessimo rendimento Stazione radioeof	Segnale debole	Sposta l'auto in un altro posizione, la ricerca

Non collegare i conduttori dell'altoparlante del cavo di alimentazione alla batteria della macchina; In caso contrario, l'unità sarà gravemente danneggiata.

Prima di collegare il cavo di alimentazione agli altoparlanti, Controlla il cablaggio dell'altoparlante nella tua macchina.

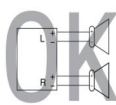
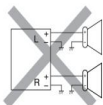
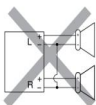

Questo dispositivo è conforme alla parte 15 delle norme e dei regolamenti dell'fcc.

L'operazione è soggetta alle due condizioni seguenti:

- 1) il dispositivo non deve causare interferenze dannose, e
- 2) il dispositivo deve accettare qualsiasi interferenza ricevuta, ivi compresa Interferenze che possono causare operazioni indesiderate

CE

Il valore massimo di SAR è di 2 w /kg quando il dispositivo è usato Omm vicino all' utente.

Avvertimento:

L'interfaccia ANT è un'interfaccia di segnale RF dedicata e non deve essere utilizzata come porta di ingresso di potenza. Qualsiasi connessione non autorizzata di fonti di alimentazione esterne comporterà un grave degrado del sistema di segnale o danni permanenti all'apparecchiatura. tutte le conseguenze e le perdite derivanti da tali Le operazioni non autorizzate sono a carico dell'utente stesso e non sono coperte dalla garanzia del prodotto.

Se la tensione del prodotto è inferiore a 12V, le condizioni di lavoro non sono garantite.

Esta descripción de la versión pública está sujeta a la configuración real del producto.

Carta di garanzia del prodotto

Periodo de garantía:

Este producto tiene derecho a 12 meses de servicio de reparación gratuito a partir de la fecha efectiva de compra.

Ambito di applicazione della garanzia:

Sotto la premessa del rispetto delle normative di utilizzo, qualsiasi guasto di prestazione causato da difetti di fabbricazione del prodotto stesso può beneficiare di servizi di riparazione gratuiti.

Clausula di esclusione di responsabilità:

Le seguenti situazioni non rientrano nell'ambito della garanzia:

1. danni causati da forza maggiore (come terremoti, incendi, inondazioni, tifoni, ecc.);
2. Malfunzioni causate da uso improprio, manutenzione e stoccaggio da parte dei consumatori;
3. danni causati da personale non autorizzato smontaggio, riparazione o modifica senza l'autorizzazione della nostra società;
4. Il certificato di garanzia non corrisponde alle informazioni del prodotto o il certificato è stato modificato o mancante;
5. Il prodotto ha superato il periodo di garanzia concordato;
6. L'usura dell'aspetto e l'invecchiamento naturale dei consumabili causati dal normale uso.

Canali di servizio:

Se avete bisogno di supporto tecnico o servizi di garanzia, contattateci tramite i seguenti metodi:

Servizio clienti Email: info@tianshi-digital.com

Sito web del servizio: <https://tianshi-digital.com>

Ti suggeriamo di dare la priorità all'avvio delle richieste di servizio tramite il cliente ufficiale canale di servizio della piattaforma di acquisto originale.

Data di acquisto		Numero di serie	
Modello prodotto		Contatto Email	

General

Voltaje de trabajo: 11V-16V

Temperatura de trabajo: -20°C-+60°C

Corriente de trabajo: 0.8A-1.2A

Temperatura de almacenamiento: -30 ° C - + 80 ° C

Descripción funcional

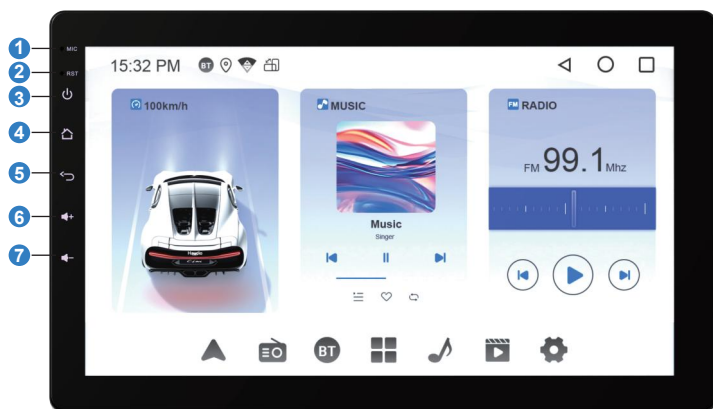

1. Agujero de micrófono incorporado
2. Restablecer (presionar con un objeto afilado)
3. Apagar o encender
4. Volver a Inicio
5. Volver al anterior
6. Vol+
7. Vol-

Lista de accesorios

Compruebe los siguientes accesorios después de abrir el paquete.



Diagrama de interfaz trasera



1. Cable de alimentación
2. Entrada/salida RCA
3. CAN Bus
4. Cable USB x 1
5. Entrada de cámara
6. Antena GPS
7. Antena de radio

Instalación

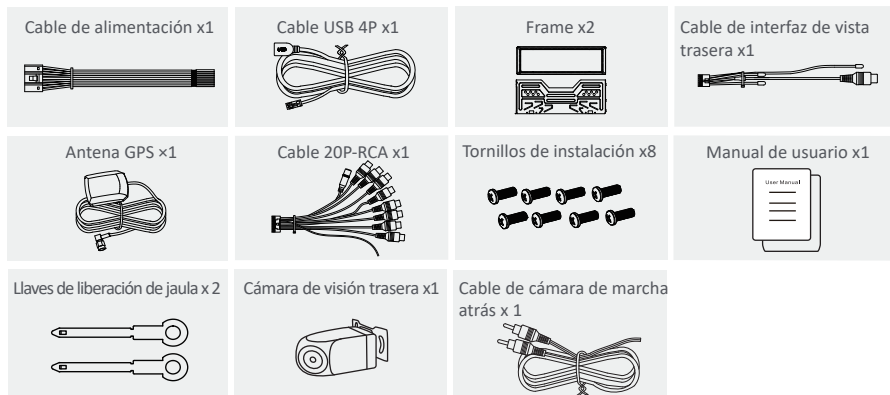

Sigue a la comunidad Haudio. Un lugar donde puedes compartir y discutir. Manténgase en contacto con los usuarios de Haudio. Obtenga el video tutorial de instalación.

Instalación

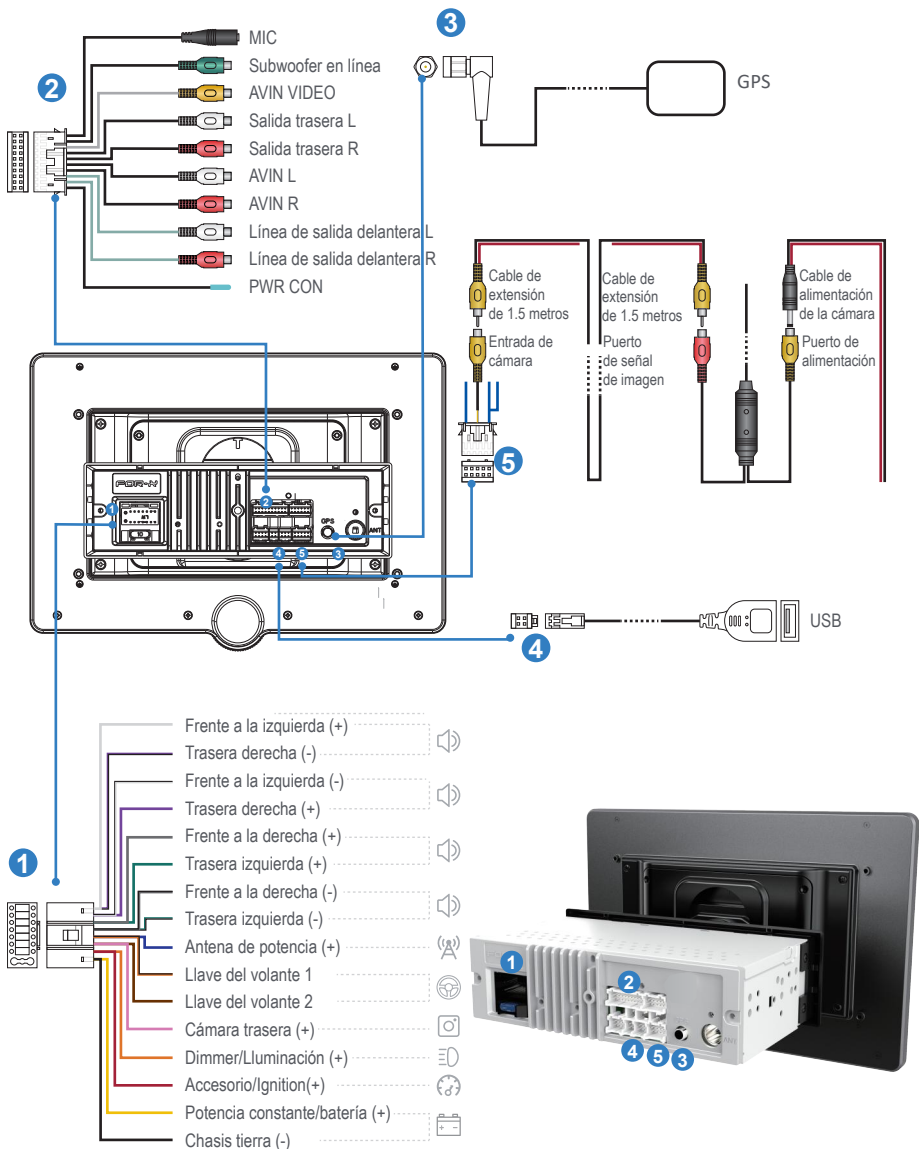

Instalación

1. Preparar herramientas:



4. Arranca el motor para verificar si el radio del coche y la cámara funcionan correctamente.



2. Retire la unidad de infoentretenimiento original del vehículo.



5. Después de conectar los cables, encienda el vehículo para verificar el encendido normal de la unidad y el funcionamiento adecuado de la cámara.



3. Desconecta el cableado de la unidad principal original.



6. El ensamblaje está completado.



Cableado de cámara de vista trasera

(opcional)

1. Monitor (no incluido en el paquete)

Fuente de alimentación 2. Cámara

3. Cámara (opcional)

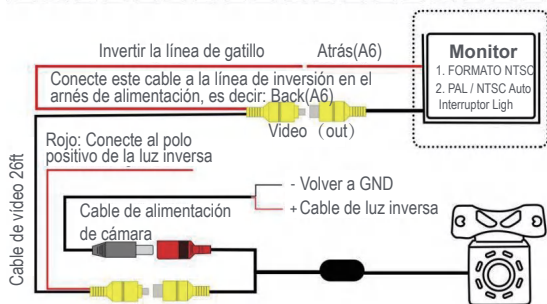
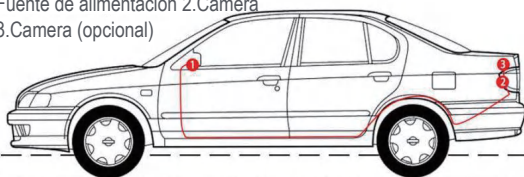

Puede llegar a la fuente de alimentación en el maletero pasando por debajo de la puerta original del coche, a lo largo del borde por encima de la puerta, o a lo largo del cableado en el techo.

1. Pasa el amés de cables de la cámara por el compartimo de almacenamiento y conéctalo a la unidad principal.



2. Oculta el cable de señal de la cámara bajo el borde de la puerta y guíalo hacia la entrada del maletero.



3. El poder de la cámara proviene de las luces traseras del vehículo



Introducción del producto

Radio

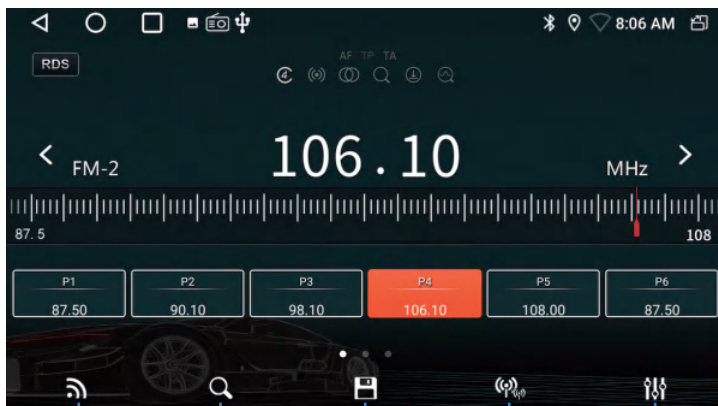

Cambiar de banda

Buscar emisoras

Guardar emisora

Cambiar entre largo / corto alcance

Ajustes de efectos de sonido

Música

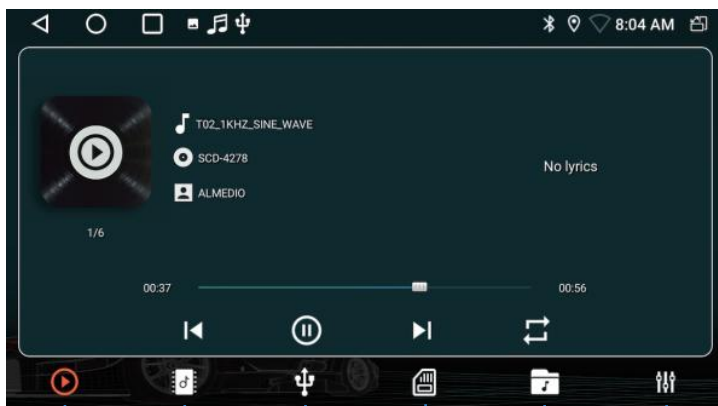

Interfaz de reproducción de música

Archivos de música local

Archivos de audio en USB

Archivos de música en tarjeta TF

Lista de música

Ajustes de efectos de sonido

Durante la reproducción de música, desliza la barra de progreso de reproducción para arrastrar al nodo de reproducción especificado.

Introducción del producto

Vídeo

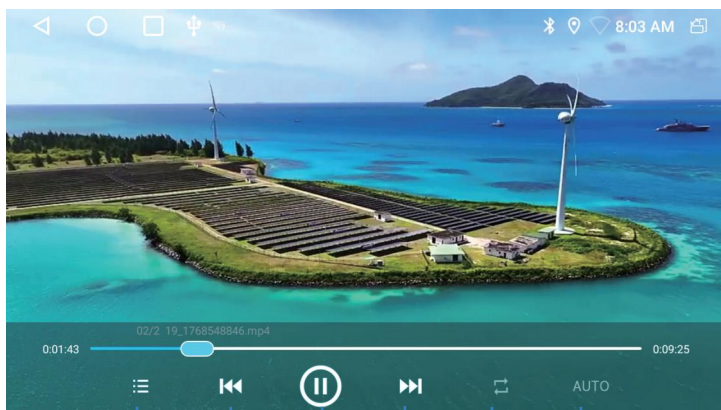

Lista de vídeos

Vídeo Evioso

Pausa

Siguiente vídeo

Modo de reproducción

AUTO

Bluetooth

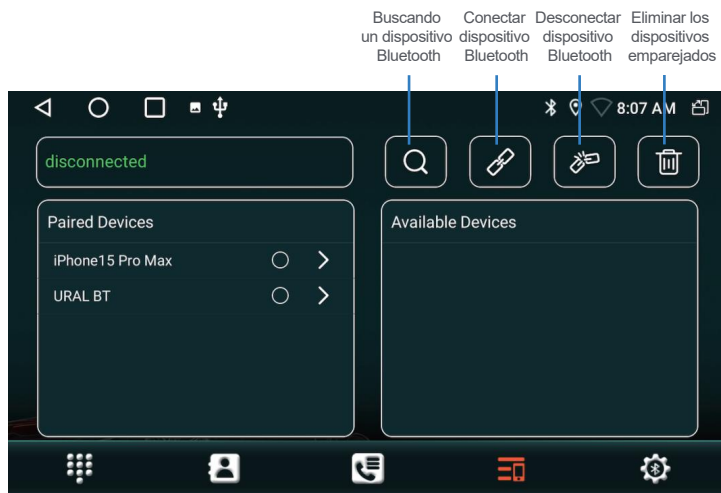

Buscando un dispositivo Bluetooth

Conectar dispositivo Bluetooth

Desconectar dispositivo Bluetooth

Eliminar los dispositivos emparejados

Comunicación telefónica Bluetooth

Libro telefónico

Registro de llamadas

Lista de dispositivos

Configuración

Introducción del producto

Configuración de Bluetooth

Restart BT power

Enciende este interruptor de alimentación para habilitar Bluetooth.

Auto Answer

Enciende este interruptor, después de que el teléfono móvil esté conectado al Bluetooth del coche, y encienda el interruptor de red de compartir Bluetooth en el móvil al mismo tiempo, el coche puede acceder a Internet a través de la red compartida por el móvil.

Auto Connect

Enciende este interruptor, después de que el teléfono móvil esté conectado al Bluetooth del coche, y encienda el interruptor de red de compartir Bluetooth en el móvil al mismo tiempo, el coche puede acceder a Internet a través de la red compartida por el móvil.

Bluetooth net

Enciende este interruptor, después de que el teléfono móvil esté conectado al Bluetooth del coche, y encienda el interruptor de red de compartir Bluetooth en el móvil al mismo tiempo, el coche puede acceder a Internet a través de la red compartida por el móvil. Consulte las introducciones detalladas sobre el método de operación del terminal móvil.

DSP

Instrucciones de funcionamiento.



Introducción del producto

Conexión inalámbrica



Haga clic en el enlace CarPlay/Android Auto/Phone



Haga clic para cambiar entre Carplay/Android Auto y Espejo

1. Presione para entrar en Zlink5, el teléfono móvil se puede conectar al dispositivo de información en el vehículo a través de Android USB y iPhone Wi-Fi.
2. Zlink5 inalámbrico: el teléfono l conecta la navegación del coche a través de BT, haga clic en Zlink5 para entrar en el cuadro de diálogo emergente y haga clic en usar Zlink5.

Zlink:(Instrucciones de conexión para algunos teléfonos móviles iOS)

1. Enciende el BT del teléfono móvil para conectar el BT de la unidad de cabeza. Después de la conexión BT del coche, la interfaz de conexión ZLink aparecerá automáticamente.
2. Confirme el uso de CarPlay en móvil.
3. Si los pasos anteriores no se pueden conectar, necesita conectar el WiFihotspot del teléfono móvil.

Directrices comunes de solución de problemas

FAULTO	RAZÓN	SOLUCIÓN
No se puede encender	Compruebe el fusible	Cambiar fusible igual que el antiguo Corriente máxima del fusible: 15A
	Algunos factores causa MPU sbagliato operación	Pulse el botón RESET en el panel por penpoint, entonces, potencia encendida
Después de las igniciones con apagado, ajuste toda la información pierde	Cambiar batería o fusible	Restablecer la información y guardar
Pobre rendimiento estación de radio eof	Señal débil	Mover el coche a otro ubicación, luego investigación

No conectar los conductores del altavoz del cable de alimentación a la batería de la máquina; De lo contrario, la unidad será gravemente dañada.
Antes de conectar el cable de alimentación a los altavoces, Controle el cableado del altavoz en su máquina.

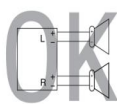
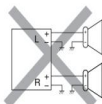
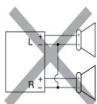

Este dispositivo cumple con la parte 15 de las normas y reglamentos de la FCC.

La operación está sujeta a las dos condiciones siguientes:

- 1) el dispositivo no debe causar interferencias dañinas, y
- 2) el dispositivo debe aceptar cualquier interferencia recibida, incluyendo Interferencias que pueden causar operaciones no deseadas

CE

El valor máximo de SAR es de 0,712W/kg cuando el dispositivo utilizó Omm cerca del usuario.

Advertencia:

La interfaz ANT es una interfaz de señal RF dedicada y no debe usarse como puerto de entrada de potencia. Cualquier conexión no autorizada de fuentes de energía externas dará lugar a una grave degradación del sistema de señal. o daños permanentes al equipo. Todas las consecuencias y pérdidas derivadas de tales Las operaciones no autorizadas serán soportadas por el propio usuario y no están cubiertas por la garantía del producto.

Si el voltaje del producto es inferior a 12V, no se garantiza la condición de trabajo.

Esta descripción de la versión pública está sujeta a la configuración real del producto.

Tarjeta de garantía del producto

Período de garantía:

Este producto tiene derecho a 12 meses de servicio de reparación gratuito a partir de la fecha efectiva de compra.

Ámbito de la garantía:

UBajo la premisa de cumplir con las normas de uso, cualquier falla de rendimiento causada por defectos de fabricación del propio producto puede disfrutar de servicios de reparación gratuitos.

Disclaimer Clause:

Las siguientes situaciones no están dentro del ámbito de responsabilidad de la garantía:

1. Daños causados por fuerza mayor (como terremotos, incendios, inundaciones, tifones, etc.);
2. Malfunciones causadas por el uso inadecuado, mantenimiento y almacenamiento por los consumidores;
3. Daños causados por personal no autorizado desmontar, reparar o modificar sin la autorización de nuestra empresa;
4. El certificado de garantía no coincide con la información del producto o el certificado se ha alterado o falta;
5. El producto ha superado el período de garantía acordado;
6. Desgaste de apariencia y envejecimiento natural de los consumibles causados por el uso normal.

Canales de servicio:

Si necesita soporte técnico o servicios de garantía, póngase en contacto con nosotros a través de los siguientes métodos:

Correo electrónico de servicio al cliente: info@tianshi-digital.com

Sitio web de servicio: <https://tianshi-digital.com>

Le sugerimos que priorice la iniciación de solicitudes de servicio a través del cliente oficial canal de servicio de la plataforma de compra original.

Fecha de compra		Número de serie	
Modelo de producto		Contacto Email	



此页只是文件说明，不做印刷用！

文件名 File Name	CVS1520-IM-V1.1	版次 Revision	V1.1
机型 Project#	CVS1520-AJ	比例 Scale	1:1
客户/品牌 Customer	Haudio	公差 Tolerance	±2mm
尺寸+P数 Size	130*185mm, 56P	设计 Designer	陈大夫
材质 Material	108g双铜	审核 Checked	张欢
工艺 technique	封面彩色印刷过光油，内页彩色印刷，骑马订册子	设计日期 Design Date	2026. 04. 09
注释: Remarks:	描述 Description		